

BP

RÉSEAU
ON
GPL

BOUCHON MÂLE À JPC

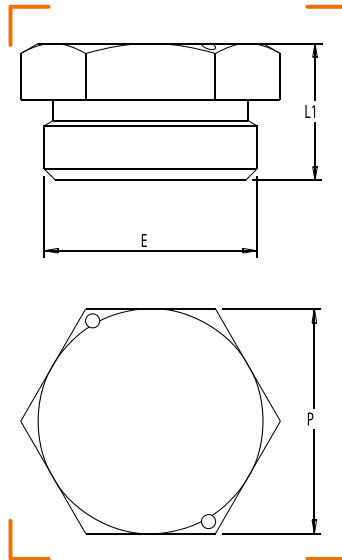

TÊTE CARRÉE

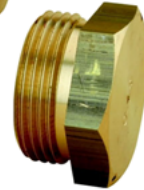









TÊTE 6 PANS

CARACTÉRISTIQUES TECHNIQUES

Normes : NF E 29-532

Température : -20°C à +60°C

Divers : Bouchon d'attente

| CALIBRE | ENTRÉE MÂLE (E) | OPTION | L1 | P | NF | RÉF. |
|---------|-----------------|-------------|----|----|---|----------|
| 20 | JPC 20 | Tête 6 pans | 20 | 32 |  | 0770-052 |
| 20 | JPC 20 | Tête carrée | 19 | 14 |  | 0770-053 |
| 32 | JPC 32 | Tête 6 pans | 22 | 46 |  | 0770-054 |
| 32 | JPC 32 | Tête carrée | 21 | 14 |  | 0770-055 |
| 40 | JPC 40 | Tête 6 pans | 25 | 60 |  | 0770-056 |
| 40 | JPC 40 | Tête carrée | 31 | 22 |  | 0770-057 |
| 50 | JPC 50 | Tête 6 pans | 25 | 65 |  | 0770-058 |
| 50 | JPC 50 | Tête carrée | 31 | 22 |  | 0770-059 |